

Thank you for choosing this model of portable air conditioner. Please read this manual carefully before installing and using this appliance. Please keep this Use and Maintenance Manual properly for future reference.

**PARAMETERS**

Model	DAC-12000
Functions	Cooling, dehumidification, fan
Cooling performance	12 000 BTU/h
Cooling performance	3.5 kW
Temperature setting range	17-30°C
Power	220-240 V/50 Hz
Rated power input - cooling	1340 W
Rated current - cooling	6 A
EER for cooling	2,64
Refrigerant	R290/ 202 g
Number of fan speeds	3
Air circulation (high/medium/low level)	360/300/270 m <sup>3</sup>
Dehumidification	39l/day
Water tank volume	0,8l
Dimensions of the device	418*375*718 mm
Packaging dimensions	478*420*868 mm
Suitable for premises	45m <sup>2</sup> (95m <sup>3</sup> )
Noise	51/53 dB
Weight	31,5 kg
Weight with packaging	35,3 kg
Controls	Smart Life/Tuya app + remote control
Window mounting kit	Universal

## SAFETY INSTRUCTIONS

### Warning

- Do not use any means to speed up the defrosting process or to clean other than those recommended by the manufacturer.
- Use the appliance in a room without heat sources (for example: an open fire, a working gas appliance or a working electric heater).
- The refrigerant is odourless.
- Use the device in a room with a floor area greater than 12 m<sup>2</sup>.
- Keep all vents clear of obstructions.
- Maintenance should only be carried out according to the manufacturer's recommendations.
- Any person involved in refrigerant handling or servicing of the refrigerant circuit should be familiar with it.

Maintenance shall be carried out only as recommended by the equipment manufacturer. Maintenance and repairs requiring the assistance of other qualified personnel shall be carried out under the supervision of a person qualified to use flammable refrigerants.

- All work procedures affecting safety equipment must only be carried out by competent persons.
- Be careful not to damage the equipment to prevent refrigerant leakage from the refrigerant line.



**Flammable material.**  
This appliance contains the flammable refrigerant R290/Propane.

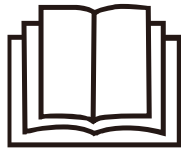

**Read the instructions carefully**



**Read the technical information**

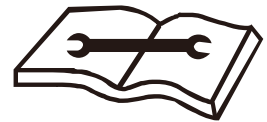

**Read service information**

**The maximum volume of refrigerant is 250 g.**

### Notes:

- The air conditioner is suitable for indoor use only.
- Place the device in a flat, dry place and keep a distance of more than 50 cm between the device and surrounding objects or walls.
- After installing the air conditioner, make sure the plug is intact and firmly inserted into the socket, place the power cord neatly to prevent someone from tripping over it or pulling the plug.
- Do not insert objects into the air conditioning air inlet and outlet, keep them clear of obstructions.
- When installing the drain hoses, make sure that they are correctly connected and that they are not deformed or bent.
- When adjusting the air outlet grille, be careful not to damage it.
- When carrying the device, make sure that it is not tilted.
- The device should not be near gasoline, flammable gas, stoves and other heat sources.
- Do not arbitrarily disassemble, overhaul or modify the equipment, otherwise the equipment will malfunction or even endanger persons and property. To avoid danger, in the event of equipment failure, ask the manufacturer or air conditioning repair and service companies to repair the equipment.
- Do not install or use the air conditioner in a bathroom or other humid environment.
- Do not switch off the device by pulling the power plug out of the socket.
- Do not place objects on the unit, avoid spilling water or other liquids into the air conditioner.
- Do not use insecticidal sprays or other flammable substances near the air conditioner.
- Do not wipe or wash the air conditioner with chemical solvents such as petrol and alcohol. If you need to clean the air conditioner, you must disconnect the power and clean it with a half-moistened soft cloth. If the unit is really dirty, scrub it with a mild detergent.
- The appliance may be used by children from 8 years of age and persons with reduced physical, sensory or mental abilities, provided they are supervised or have been instructed in the safe use of the appliance and understand the dangers involved. Children must not play with the appliance. Cleaning and maintenance must not be carried out by unsupervised children.
- If the power cord is damaged, it must be replaced by the manufacturer, its service representative, or similarly qualified

persons to prevent injury.

- The appliance must be installed in accordance with national wiring regulations.

#### **TRANSPORT, MARKING AND STORAGE OF UNITS**

1. Transport of equipment containing flammable refrigerants

Compliance with traffic regulations

2. Marking devices with tags

Compliance with local regulations

3. Disposal of equipment using flammable refrigerants

Compliance with national rules

4. Storage of equipment/appliances

Storage of equipment should be in accordance with the manufacturer's instructions.

5. Storage of packaged (unsold) equipment

The protection of storage containers should be designed so that mechanical damage to the equipment inside the container does not cause the refrigerant charge to leak.

The maximum number of pieces of equipment that may be stored together is determined by local regulations.

The appliance must be stored in such a way as to prevent mechanical damage.

#### **Remark:**

The appliance is filled with flammable R290 gas and the maximum refrigerant charge is 250 g.

The GWP value of R290 refrigerant is 3.

If repairs are needed, contact the nearest authorised service centre and follow the manufacturer's instructions only, or contact air conditioning service and repair companies.

#### **CHARACTERISTICS AND IDENTIFICATION OF PARTS**

##### **FEATURES**

- ※ A new look with a compact design, sleeker and more modern.
- ※ The louvers automatically rotate and the direction of the cool air exhaust is adapted to the needs of the consumer.
- ※ Elegant and simple design, remote control that can be placed in a storage holder at the back of the unit.
- ※ Simple operation, control panel with digital LED display and remote control with LCD display.
- ※ 24-hour timer function.
- ※ Exhaust hose and fasteners that are easy to install.
- ※ Remote control via WiFi network using the Smart Life / Tuya app.

**DESCRIPTION OF PARTS :**

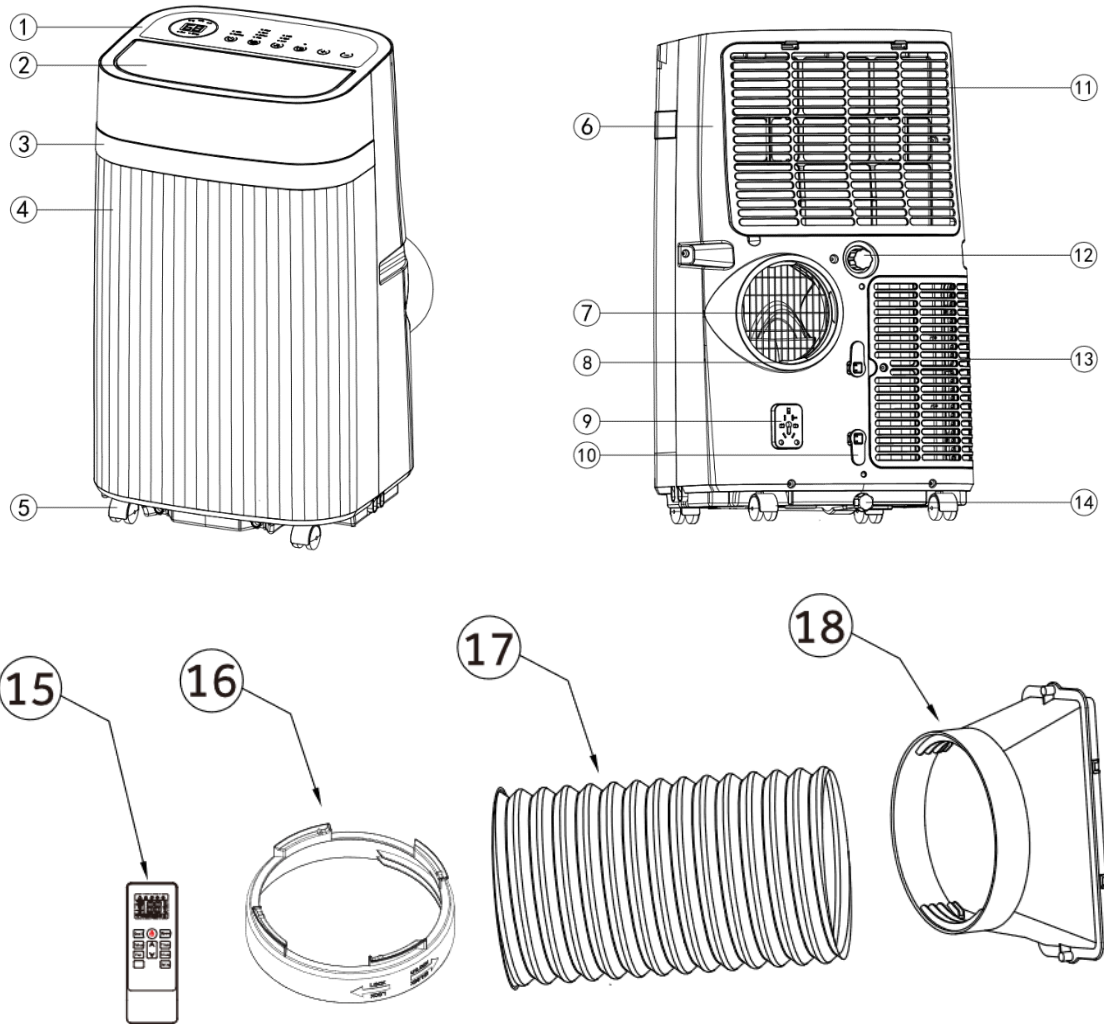

- |  |  |
|--|--|
| <ul style="list-style-type: none"> <li>1. Control panel</li> <li>2. Air exhaust opening</li> <li>3. Decorative panel</li> <li>4. Front casing</li> <li>5. Rolling castors</li> <li>6. Rear casing</li> <li>7. Protective grille for exhaust outlet</li> <li>8. Connection for exhaust hose</li> <li>9. Universal socket</li> </ul> | <ul style="list-style-type: none"> <li>10. Winding bracket for power cable</li> <li>11. Location of the upper filter</li> <li>12. Drain hole and cap</li> <li>13. Location of the bottom filter</li> <li>14. Drain hole and cap</li> <li>15. Remote control</li> <li>16. Circular connection connector</li> <li>17. Exhaust hose</li> <li>18. Adapter for connection to the window assembly</li> </ul> |
|--|--|

**OPERATION AND SETTINGS**  
**DESCRIPTION OF THE CONTROL PANEL U**

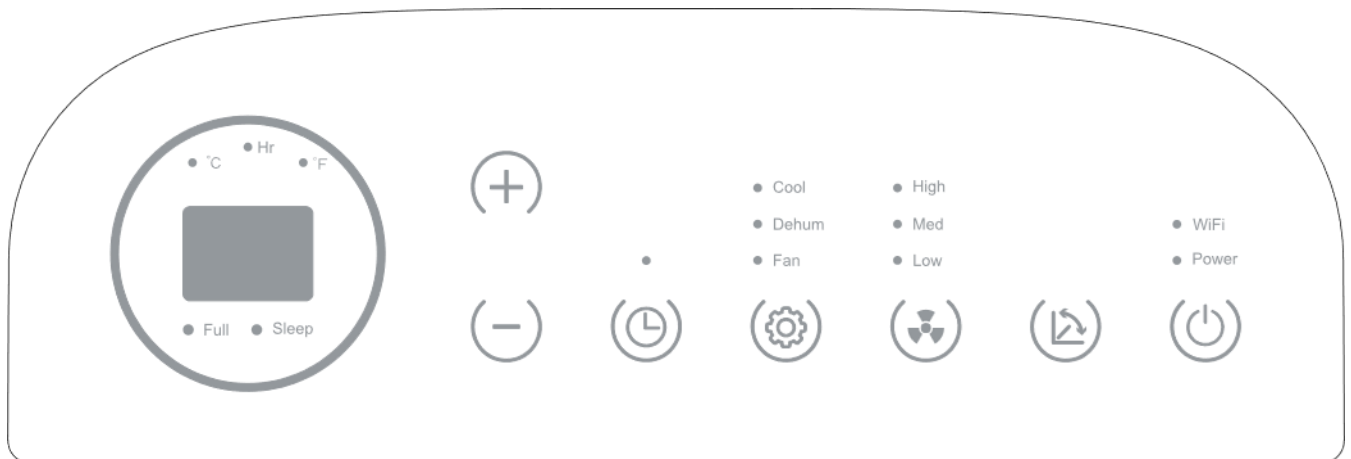

**A. TIMER BUTTON**

Set the time (from 1 hour to 24 hours) after which the air conditioner should be switched off or on. After programming the time delay, the timer light will come on.

**If the air conditioning is on:**

1. Press the Timer button.
2. Press the up (+)/down (-) buttons to select the number of hours you want the air conditioner to run before switching off.

NOTE: Wait approximately 5 seconds for the shutdown time to be saved.

**If the air conditioning is off:**

1. Press the Timer button.
2. Press the up/down buttons to select the number of hours you want the air conditioner to remain in off mode before turning on.

NOTE: Wait approximately 5 seconds for the power-on time to be saved.

**Cancel timer:**

- Press the timer button once, the remaining hours will flash, press the timer button again and the timer will be cancelled.

◆ **Long press the timer button and the WiFi light will flash. At this point, a WiFi connection can be established. After a successful connection, the WiFi light will remain on.**

**B. FAN SPEED BUTTON**

The fan speed can be adjusted from low speed to high speed when the air conditioner is running.

NOTE: The fan speed cannot be adjusted when the unit is in dehumidification mode.

Press the Fan Speed button to switch between three speeds. The corresponding fan speed indicator will light up.

**C. CONTROL PANEL DISPLAY**

Displays the set temperature in degrees Fahrenheit or degrees Celsius or the remaining hours of the set on/off time. The corresponding indicator light for that value will illuminate.

**D. UP AND DOWN ARROW BUTTONS (+ and -)**

Adjusts the temperature or clock in the timer settings.

**Temperature setting:**

The temperature can be set between 17°C and 30°C when the air conditioner is in Cool mode.

1. Press the Mode button until Cool is selected.
2. Press the up or down arrow button to select the temperature.

NOTE: The temperature cannot be adjusted when the air conditioner is in fan or dehumidify mode.

NOTE: Pressing the up arrow and down arrow buttons simultaneously allows you to choose between displaying the

temperature in °C or °F. The corresponding indicator will light up.

#### E. MODE BUTTON

Press the Mode button to switch between modes of operation. The corresponding indicator will light up:

Cool - Cool - cools the room to the set temperature

Dehumidification -Dehumidification -Reduces humidity in the room

Fan - circulates the air in the room without cooling.

#### F. POWER BUTTON

Switches the air conditioning power on/off.

**NOTE:** Turning off the power by pressing the Power button does NOT disconnect the appliance from the power source.

Press the power button. The power indicator lights up.

#### G. AUTO SWING BUTTONS

Opens and closes the louvers to direct the airflow.

#### H. SLEEP MODE

Press the timer button  and the up arrow button  at the same time to turn sleep mode on or off.

### REMOTE CONTROL

#### 1) The operation with this remote control is as follows:

- A. ON/OFF button: press this button to start or stop the unit when it is in operation;
- B. TIMER Button: Press this button to set the automatic on/off time of the unit;
- C. Fan SPEED button: press this button to select high, medium or low fan speed (except for dehumidification mode);
- D. Up button: press this button to increase the temperature or timer setting;
- E. Down button: press this button to lower the temperature or timer setting.
- F. Cool button: press this button to select the cooling mode;
- G. Dehum button: press this button to select the dehumidification mode;
- H. Fan button: press this button to select the fan mode;
- I. Sleep button: press this button to enter sleep mode.
- J. Swing button: press this button to activate the Swing function.
- K. The up arrow and down arrow buttons allow you to select between displaying the temperature in °C or °F by pressing them simultaneously for 5 seconds.



#### Notes:

- Use only alkaline batteries. Do not use rechargeable batteries.
- When replacing batteries, always replace both batteries with new ones, do not mix old and new batteries.
- If you will not be using the air conditioner for an extended period of time, remove the batteries from the remote control.



#### ATTENTION

1. If electrolyte from the batteries gets on your skin or clothes, wash them well with clean water, do not use the remote control if electrolyte is leaking from the batteries.
2. The chemicals in the batteries could cause burns or other health hazards.

## PROTECTIVE FUNCTIONS

### 1. Filling the inner container with water:

When the inner container is filled with water, both the "FULL" and "FL" water fill indicators flash on the display.

### 2. Compressor delay protection function

This device offers protection against restarting the compressor. In addition to allowing the compressor to start immediately when the unit is first switched on, a 3 minute start delay is set after the compressor is switched off.

## Handling and transport

### 1. Handling and moving the unit

Use the handles on the side panels to move the unit.

Remark:

- Don't catch the device behind the blinds.
- When handling or moving the device in any way, place it in an upright position.
- Before handling or moving the unit, drain the water completely from the unit to prevent spillage.
- Remove the remote control from the storage compartment and store it.

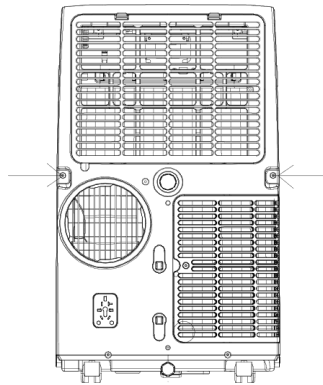

## INSTALLATION AND SETUP

### 1. Installation

Warning: leave this mobile air conditioner upright for at least 2 hours before starting it up for the first time.

This air conditioner can be conveniently moved indoors; keep it upright when moving it. The air conditioner must be placed on a flat, hard surface. Do not install or operate this air conditioner in a bathroom or other humid environment.

#### 1.1 Fitting the exhaust hose and adapter

- 1) Remove the exhaust hose assembly and its adapter from the plastic bag.
- 2) Extend the exhaust hose at one end, screw the round end of the adapter into the exhaust hose counterclockwise.

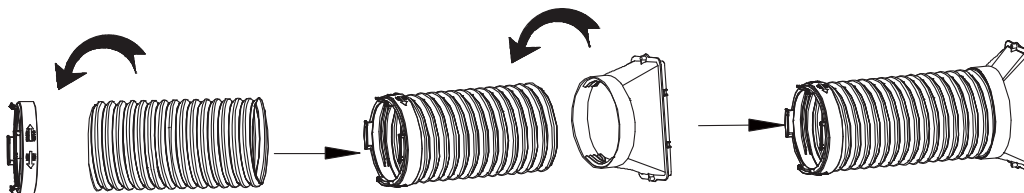

#### 1.2 Installing the exhaust hose in the window

- a) Move the unit and the exhaust hose in front of the window and keep it at least 50 cm away from walls or other objects.
- b) Install the rectangular exhaust hose adapter into the corresponding rectangular hole in the window seal kit assembly.

1.

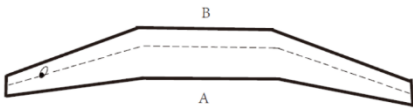

First, open the window and clean all surfaces to which the dry strip will be attached with a zipper. Clean the frame and sash surfaces so that they are free of dust and grease.

Open the self-adhesive part of the Velcro tape and attach it to the window sash.

NOTE: Make sure the window can still be closed without damaging the Velcro zipper on the frame or window sash.

2.

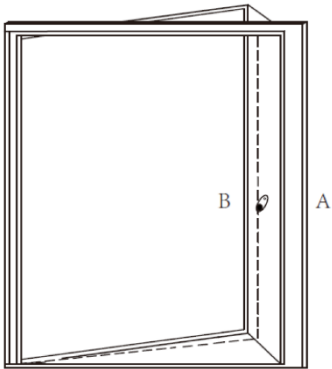

Attach the Velcro strip to the window sash (side A) from the outside or inside. On the side where the handle is.

NOTE! Make sure the window can still be closed without damaging the dry zipper on the frame or window sash.

3.

First attach the wide part (side A) of the sealant (zipper is closed) with the open through the window. Start in the middle and then attach left and right or up and down on the window frame.

4.

Close the window and make sure that the window sealing kit is not tilted or pushed.

5.

Attach the narrow side B (zipper closed) from the center left and right or up and down to the wing.

6.

Open the window slightly and use the zipper to pull the hose through the sealing kit windows.

7.

The window sealing kit is now ready for use.

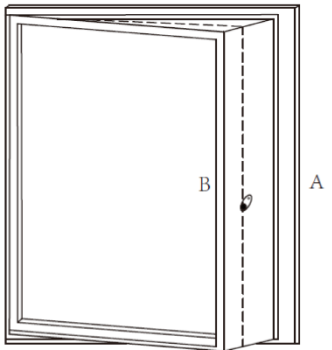

#### Important notes:

The length of the exhaust hose is 280-1500 mm and depends on the specification of the air conditioner. Do not use a longer hose or replace it with other different hoses as this may affect the function of the air conditioner. The exhaust hose must be smooth, otherwise the air conditioner may overheat and shut down as the air conditioner will not function properly.



## INSTRUCTIONS FOR WATER DISCHARGE

This portable air conditioner has two drain holes, an upper and a lower one. We can use two methods of draining: manual draining and continuous draining;

### 1. Manual discharge:

This unit is designed with a high efficiency self-evaporating system and it is recommended to use manual drain in cooling mode, all condensate will be recycled in the unit to ensure there is enough water to recycle in the unit to cool the condenser and increase cooling capacity; however, in extreme humidity, the water tank inside the unit will be full, the LED display will show "FL", it needs to be drained manually from the bottom drain hole.

- 1) Place the drain container under the water outlet at the rear of the appliance.
- 2) Unscrew the drain cover;
- 3) After draining the water, insert the plug and screw the cover firmly onto the water outlet.

#### Notes:

- A. If necessary, move the unit carefully to prevent water leakage.
- B. Protect the drain cover and water plug from damage.
- C. Tilt the unit slightly backwards when draining the water.
- D. Screw in the drain hole if the container you are pouring water into is starting to fill. This will prevent water from leaking and soaking the floor or carpet.
- E. The water stopper and drain cover must be firmly installed to prevent water from spilling onto the floor when the unit is restarted.

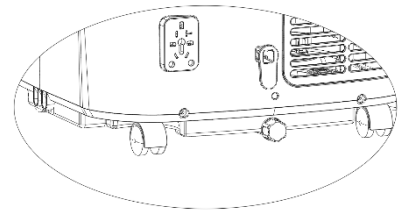

### 2. Continuous discharge

- 1) Unscrew the drain cover.
- 2) Connect the drain hole with a PVC drain hose  $\phi 13$  mm, as deep as possible to avoid leaks (hose must be purchased).
- 3) Pull the drain hose to the drain or outside.

#### Notes:

1. The drain hose must be installed before the unit is put into operation.
2. It is recommended to use manual water drain when the unit is in cooling mode to ensure sufficient water is recycled in the unit to cool the condenser and increase cooling capacity.
3. Place the drain hose in an inaccessible place, no higher than the drain hole, and keep it straight without any bending.
4. When draining continuously, keep the drain cover and drain plug properly installed.

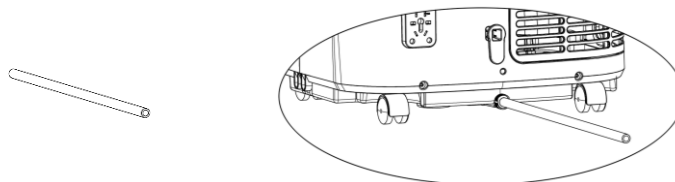

### 3. Continuous discharge in dehumidification mode: a higher drain hole is ideal.

- 1) Unscrew the drain cover and disconnect the water stopper.
- 2) Connect the drain hole with a PVC drain hose  $\phi 13$  mm to a depth of 8 mm-10 mm (hose to be purchased).
- 3) Pull the drain hose into the bathroom or outside.

#### Notes:

1. The drain hose must be installed before the unit is put into operation.
2. Place the drain hose in an inaccessible place, no higher than the water outlet, and keep it straight without any bend.
3. When continuously draining from the top drain, keep the bottom drain cover and its cap properly installed.

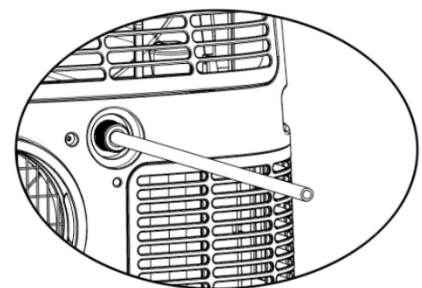

## MAINTENANCE AND SERVICE

Before servicing, switch off the appliance and remove the plug from the socket or send the appliance to a service centre.

### 1. Surface cleaning

Clean the surface of the unit with a damp and soft cloth, but do not use chemical solvents such as alcohol and gasoline to avoid damaging the unit.

### 2. Cleaning filters

Clean the filter every two weeks

Note: If the filter is clogged with dust or other obstructions, the performance of the unit is affected.

### 3. Clean the filter

- 1) Grasp the filter handle and carefully remove it in the correct direction shown by the arrow.
- 2) Hold the unit with your hands and remove the filters in the correct direction shown by the arrow.

#### Note:

- a) Remove the filter with even force to avoid twisting or damaging it.
- b) Clean the filters gently in warm water (about 40 °C) mixed with detergent and dry them in the shade.

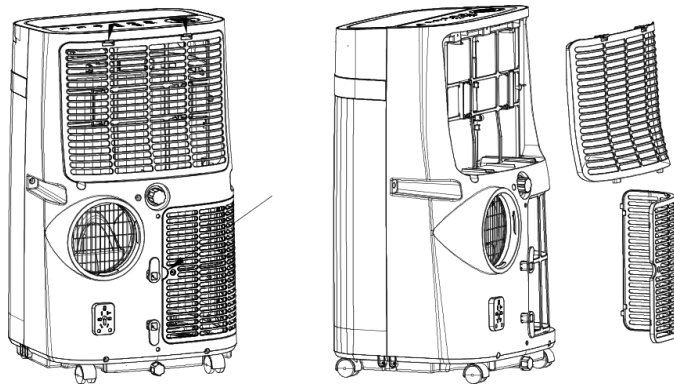

#### Notes:

- a) Don't squeeze the net.
- b) Do not use sharp objects or brushes on the mesh.

### 4. Clean the handles and storage compartment of the remote control.

- a) Remove the remote control
- b) Clean the handle position and the storage compartment of the remote control with a damp and soft cloth.

Note: Be careful not to drip water into the device.

## STORAGE AT THE END OF THE SEASON

1. Unscrew the drain cover and then pull out the stopper to drain the water completely.

Note: The inclination angle of the unit must be  $\leq 30^\circ$ .

2. Allow the unit to run in fan mode for half a day to ensure that the inside of the unit is completely dry and not mouldy.
3. Turn off the instrument, pull the plug, and then wrap the power cord around the wire winding post, insert the plug into the universal mounting hole on the rear panel of the instrument, install the water plug and drain plug.
4. Remove the heat sink hose assembly, clean it and store it properly.

#### Remark:

1. Hold the exhaust hose assembly with both hands when removing it.
2. Remove the fasteners on the exhaust air outlet and pull out the exhaust hose assembly.
3. Pack the air conditioner properly in a plastic bag and place it in a dry place with suitable dustproofing measures and keep it out of the reach of children.
4. Remove the batteries from the remote control and store them properly.

**Note: Ensure that the unit is stored in a dry place. All accessories of the unit must be properly protected together.**

## PROBLEM SOLVING

Check the unit and the suggestions below before seeking professional service, but never disassemble or repair the unit yourself, as you could be injured or your property damaged.

Trouble	Cause	Remedy
The unit will not start	Power failure	Connect the device to a live power outlet and switch it on.
	Tank full and tank indicator lights up	Drain the water from the reservoir.
	Ambient temperature too low or too high	We recommend using this unit in the range of 5-35°C.
	The room temperature is lower than the set temperature in cooling mode.	Change the temperature setting
Poor cooling effects	Direct sunlight	Pull the curtains in the room
	Doors and windows are open or there are other heat sources in the room.	Close doors and windows, remove other heat sources.
	Contaminated filter	Clean or replace the filter.
	Blocked air inlet or outlet	Remove obstacles
High noise level	The unit is placed on an uneven surface.	Place the unit on a level and firm place (may reduce noise).
Compressor not working	Starting the overheating protection.	Wait 3 minutes for the temperature to drop, then restart the machine.
Remote control does not work	Too much distance	Bring the remote control closer to the air conditioning unit, pointing the remote control directly at the unit.
	The remote does not point directly at the unit.	
	Batteries have low voltage	Replacing batteries
LED displays error code "E1"	Cooling pipe temperature sensor failure	Checking the tube temperature sensor and related circuits
LED displays error code "E2"	Room temperature sensor failure	Check the room temperature sensor and related circuitry
LED displays error code "E4"	Protection against freezing	When the freeze protection ends, the function automatically resumes - 3 min.
Water fill indicator light	The reservoir inside the unit is full.	Drain the water and restart the machine.

## SMART LIFE/TUYA APP

Details on connecting this device to the **Smart Life / Tuya Smart** mobile app can be found on **Youtube.com** under "**Solight DAC app instructions**".

- ◆ **Long press the timer button and the WiFi light will flash. At this point, a WiFi connection can be established. After a successful connection, the WiFi light will remain on.**

### Quick application guide:

1. Make sure your mobile phone is connected to Wi-Fi.
2. To download the app, search Google Play (for Android) / App Store (for iOS) for the "Smart Life" or "Tuya Smart" app.

### Registration

1. When you open the mobile app, click on the Register button.
2. Enter your email address and wait for the verification code to be sent to you. Then enter the verification code into the mobile app.
3. Create a password for your account.

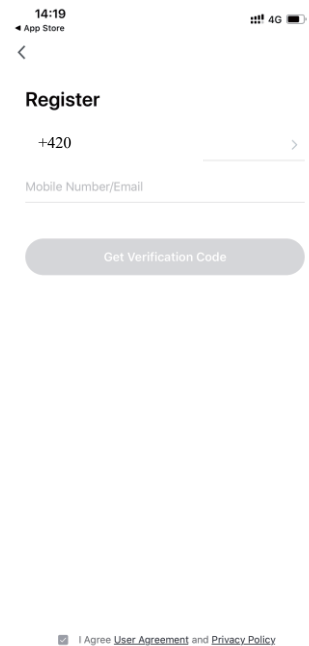

### Adding a device to the mobile app

Automatic pairing:

1. Click the "+" in the upper right corner, or the "Add Device" button.
2. Turn on Bluetooth and follow the instructions in the app.

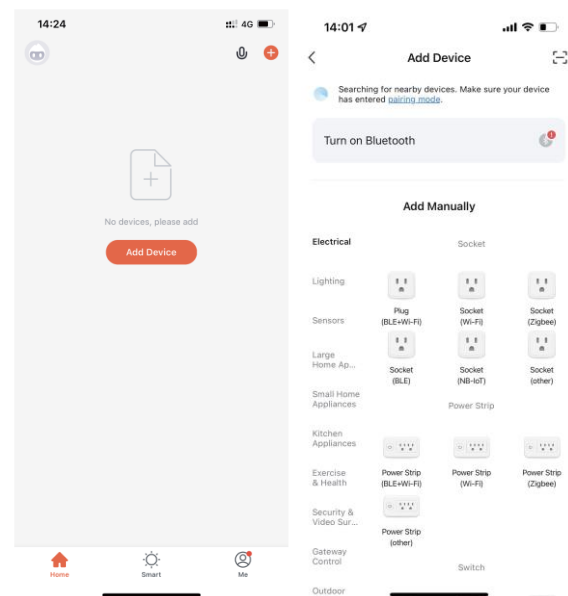

- When connected to Bluetooth, the device is automatically displayed.
- Click on "Go to add"

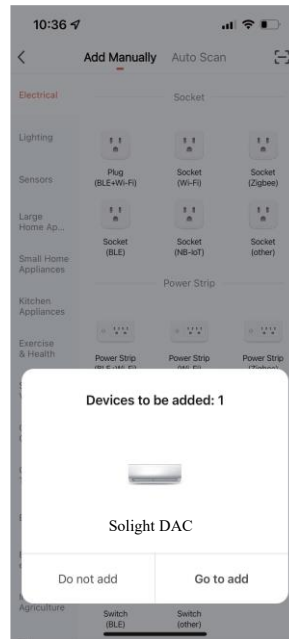

- Wait until the device has successfully connected.
- Click "Next" to finish. The device is ready for use.

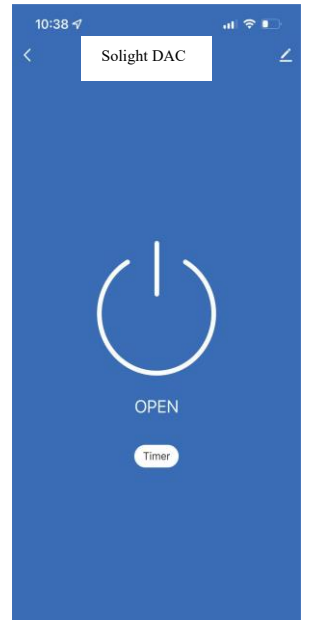
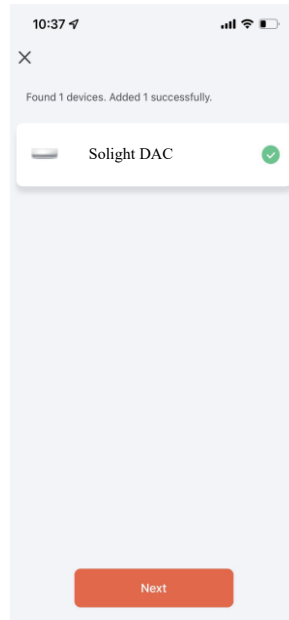

Manually add a device:

- If the device is not added automatically, add it manually.
- From the "Large Home Appliances" category, select "Air Conditioning" (Wi-Fi)

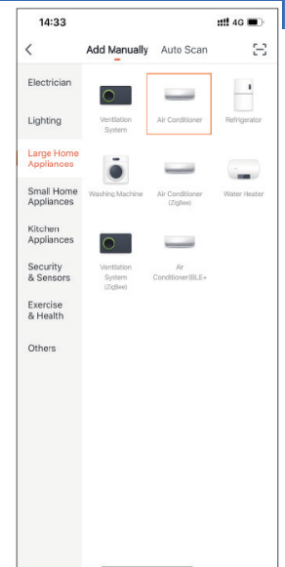
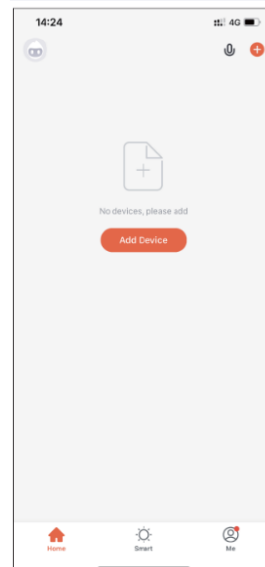

- Press and hold the "Timer" button for 5s, the Wi-Fi icon on the display will flash.
- Confirm with the "Confirm indicator rapidly blink" button. If it does not blink, follow the "Reset Device step by Step" instructions in the application and repeat adding the device. Enter your Wi-Fi password and confirm.

- Wait for the device to connect.
- When you are finished, click "Done".

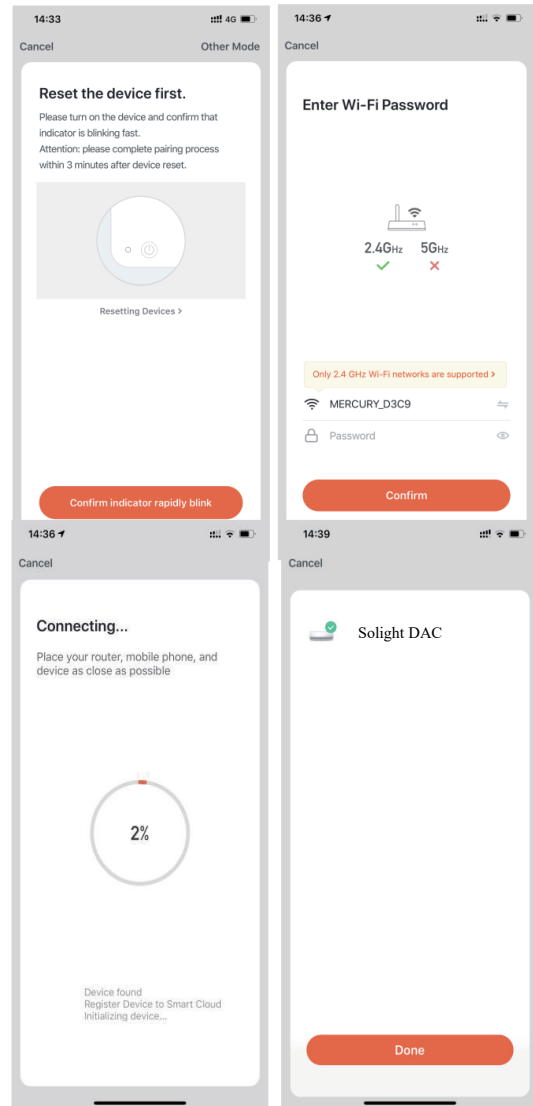

### Controls

- Press the "On" button to turn on the device.
- Press the "Timer" button to turn on the timer.

Now you can control your device from anywhere using the mobile app.

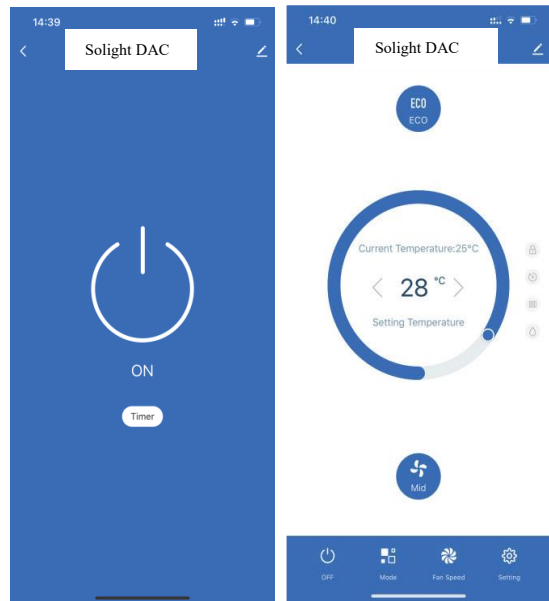

3. Click the "Mode" button to select the mode.
4. Click on "Fan Speed" to select the fan speed.

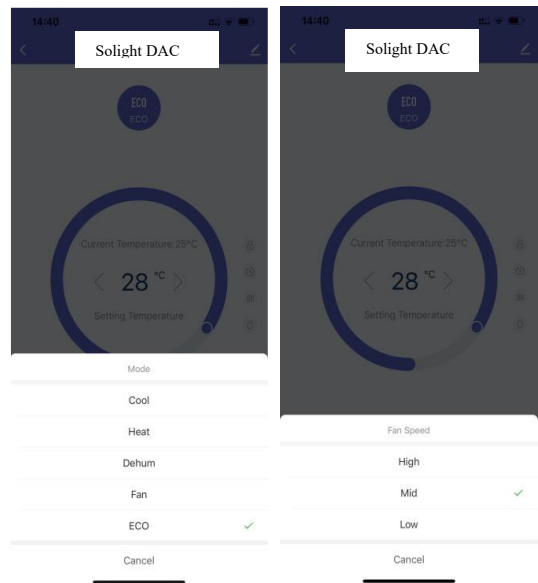

5. Click on "Setting"
6. Click on the pencil icon in the right corner for more setting options.

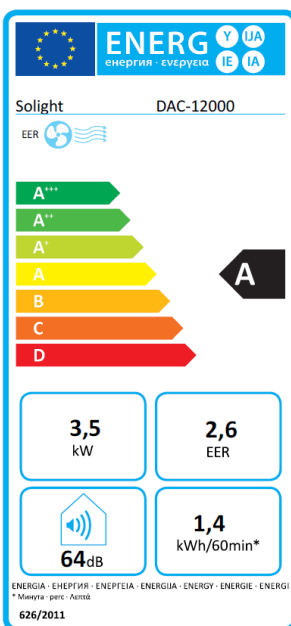
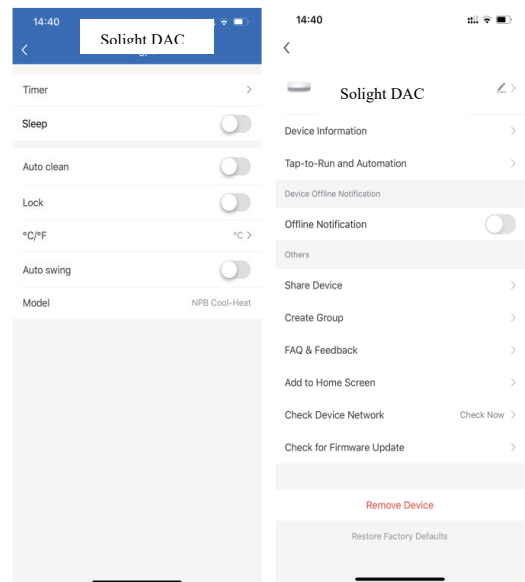

The product has been issued with a CE declaration of conformity in accordance with the applicable regulations. On request from the manufacturer: [info@solight.cz](mailto:info@solight.cz), or downloadable from [www.solight.cz](http://www.solight.cz).



**SOLIGHT**

Solight Holding, s.r.o., Na Brně 1972, Hradec Králové 500 06, Czech Republic.